

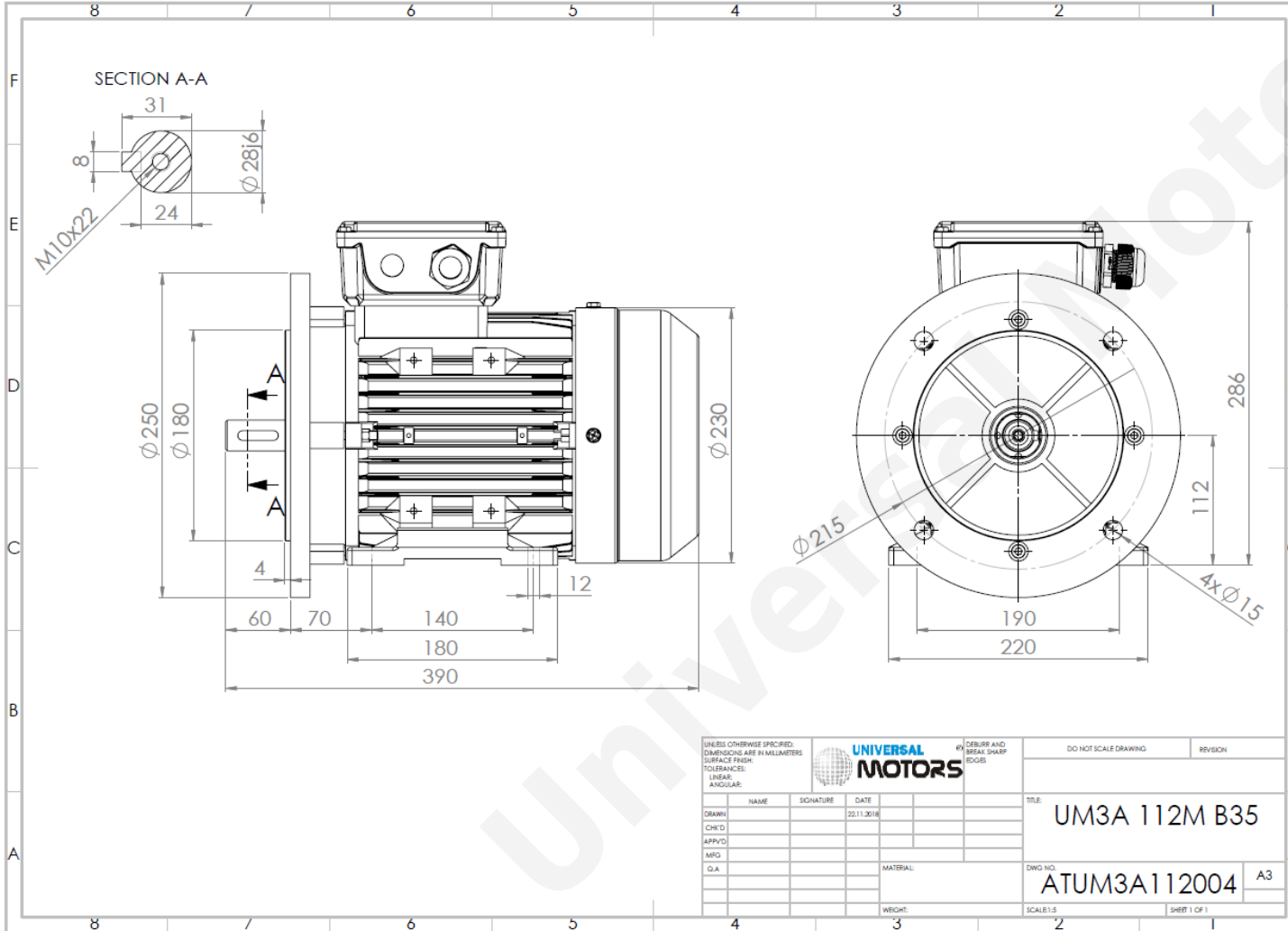

TECHNICAL DATA

Three Phase Electric Motors - Aluminum Frame
 PE31 112M-2
 4 kW / 5.5 Cv
 2895 RPM



Motor type:	PE31 112M-2
Output:	4 kW / 5.5 Cv
Speed (min ⁻¹):	2895 RPM
Frequency:	50 Hz
Voltage:	400 V
Current:	7.4 A
Power factor (Cos ϕ):	0.88
Poles:	2
Insulation class:	F
Temperature rise Class:	B
Efficiency 50%:	86.3 %
Efficiency 75%:	87.2 %
Efficiency 100%:	88.1 %
Torque:	13.2 N.m
Tstarting/Tnominal:	2.3
Istarting/Inominal:	8.3
Tmaximum/Tnominal:	2.3
Noise:	83 Db(A)
Weight:	34 Kg
Bearing DE:	6306 2Z C3
Bearing NDE:	6306 2Z C3

Regime - S1

Altitude - 1000m

Environment Temperature - 40°C

CONTACTS:

UNIVERSAL MOTORS Tel: +351 252 299 080
 Rua de São Brás,745 Fax: +351 252 299 089
 4480-782 VILA DO CONDE Mail: geral@universalmotors.pt

* References applied only in the UK